

FITTING INSTRUCTIONS for...

- BMW F750GS ('18 on)
- BMW F850GS ('18 on)
- BMW F850GSA ('18 on)
- BMW R1250GS ('18 on)
- BMW R1250GSA ('19 on)

Preparation

Remove original handguards if fitted along with bar end weight and plastic support brackets from the mirror posts.

Fitting Procedure

Shown for left side, repeat for right side with applicable parts.

Loosely assemble clamp and saddle (4) to the handlebar next to the mirror/clutch lever bracket. **See Image 1.**

Loosely attach the handguard backbone to the handlebar end with original bar weight, spacer/s (9) and bolts (7) & (8) as per diagram.

Note: F750GS requires two spacers (9) each side.

The preferred backbone position is horizontal or slightly below when viewed from the side.

Tighten all bolts in the following order (7), (8) then (5) and (6) evenly. Use recommended torque specifications over page.

Fitting Tip:

Depending on where the clutch and brake controls have been positioned it may be necessary to move them towards the handlebar end by a few millimetres to achieve a correct fit. **See Image 2.**

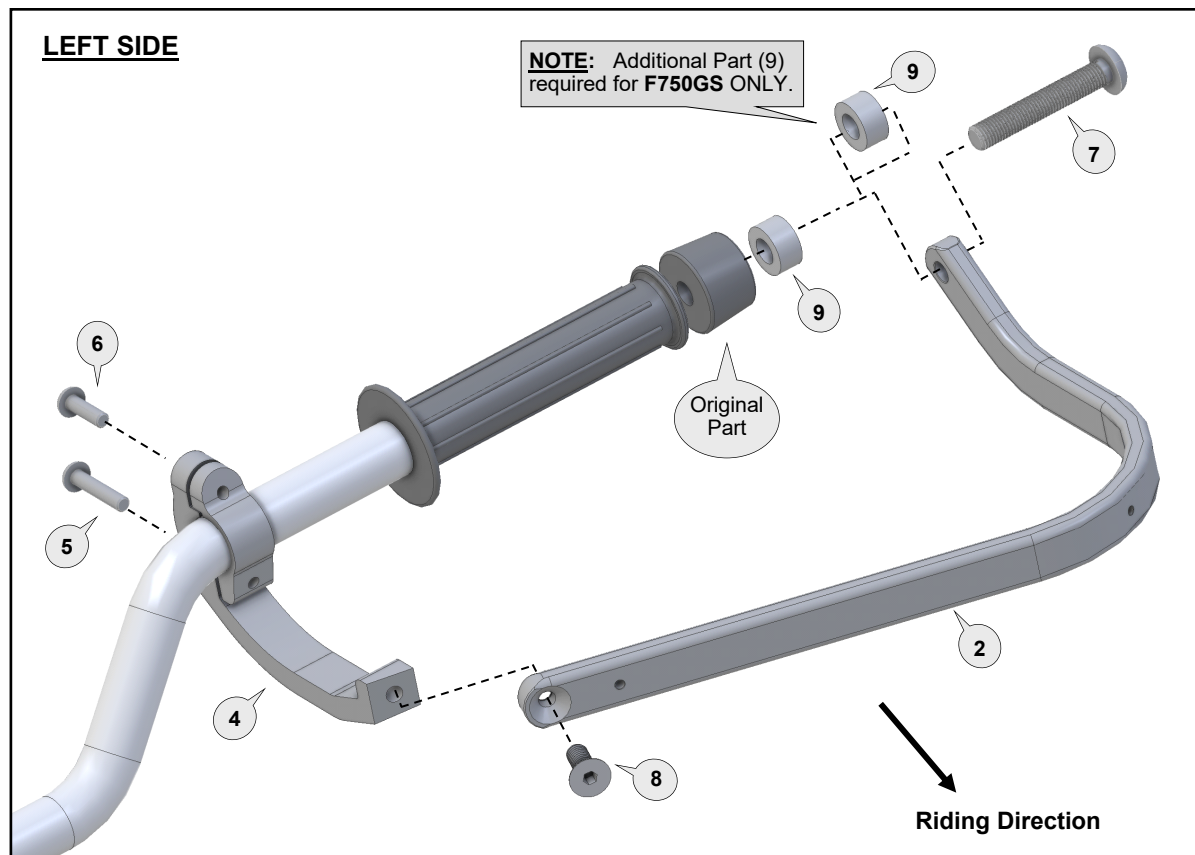
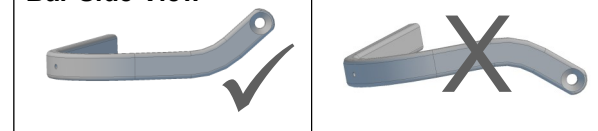



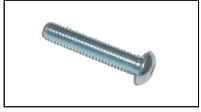

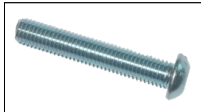



Image 1

← Clamp location on handlebar

Bar Side View



<p>1 Aluminium Bar - R</p>  <p>PN: BAR-V-131-R Pcs. 1 Right</p>	<p>2 Aluminium Bar - L</p>  <p>PN: BAR-V-131-L Pcs. 1 Left</p>	<p>3 Clamp Frame/Saddle-R</p>  <p>PN: CFS20-R Pcs. 1 Right</p>	<p>4 Clamp Frame/Saddle-L</p>  <p>PN: CFS20-L Pcs. 1 Left</p>	<p>5 Button Head Bolt 30mm</p>  <p>PN: M6X30BHCSZP Pcs. 2</p>	<p>6 Button Head Bolt 20mm</p>  <p>PN: M6X20BHCSZP Pcs. 2</p>	<p>7 Button Head Bolt 70mm</p>  <p>PN: M10X70BHCSZP Pcs. 2</p>	<p>8 Flat Head Bolt 25mm</p>  <p>PN: M8X25FHCSZP Pcs. 2</p>
---	--	--	--	---	---	--	---

9
Spacer



PN: SP10-20-10
Pcs. 4

Personalise Your Protection
Guard options sold separately

JET JET-003
VPS VPS-003
Storm STM-003
CARBON BCF-003

Recommended Torque Settings	
M6	10 Nm (7.4 lbf ft)
M8	20 Nm (14.8 lbf ft)
M10	21 Nm (15.5 lbf ft)

CAUTION:

Installation of the handguard is safety-relevant work and can be complicated. We recommend the installation be performed by a motorcycle service technician. Rideworx accepts no liability for damages caused by improper mounting. All screws, bolts and nuts, including all replacement hardware provided by Rideworx, should be tightened to the torque specified in the table. After the first 50km of riding check all screws, bolts and nuts are tightened to the correct torque. We recommend a medium strength liquid thread lock product on all fasteners.

WARNING:

Check operation of all handlebar controls, specifically the throttle, front brake, kill switch and clutch to ensure they are operating correctly and are in accordance with the OEM specifications. Do not ride the motorcycle if any controls are not operating correctly or if rear view mirror vision is obscured. Check periodically that all bolts are tight.



Email: info@barkbusters.net
Web: www.barkbusters.net



Disclaimer:

A failure to follow these fitting instructions could cause serious injury, death or property damage. These handguards are intended solely for use with motorcycles/ATV/snowmobiles/scooters that have not been modified. They are not designed to prevent injury or death while riding or in an accident or crash. The user must ensure that all controls are free of the handguards every time that they ride. By installing and/or using this product you acknowledge that you accept these terms and have followed the fitting instructions.