



**FITTING INSTRUCTIONS FOR AB0061 LOWER ADVENTURE BARS**  
**HONDA AFRICA TWIN ADVENTURE SPORTS DCT/NON DCT 2020-**  
**CAN ONLY BE FITTED IN CONJUNCTION WITH AB0060 UPPER ADVENTURE BARS**



**This kit contains the items pictured and labelled over page.**

**Some parts may be shown for clarity of instructions only.**

**Do not proceed until you are sure all parts are present.**

**Please read all instructions before proceeding.**

**IF IN ANY DOUBT WHEN FITTING OUR PRODUCTS, CONSULT ONE OF OUR DEALERS  
OR HAVE FITTED BY A QUALIFIED TECHNICIAN.**

Please note that the way the kit is packed does not necessarily represent the way of mounting to the bike.

**DIGITAL COPIES OF THESE INSTRUCTIONS ARE AVAILABLE FROM**

**[WWW.RG-RACING.COM](http://www.rg-racing.com)**

R&G

Unit 1, Shelley's Lane, East Worldham, Alton, Hampshire, GU34 3AQ

Tel: +44 (0)1420 89007 Fax: +44 (0)1420 87301 [www.rg-racing.com](http://www.rg-racing.com) Email: [info@rg-racing.com](mailto:info@rg-racing.com)



<b><u>TOOLS REQUIRED</u></b>	<b><u>GENERAL TORQUE SETTINGS</u></b>
<ul style="list-style-type: none"> <li>• Set of metric Hex keys to include 4,5 &amp; 6mm.</li> <li>• Set of metric sockets and wrench. To include 10, 12, 13, 14 &amp; 17mm.</li> <li>• Torque Wrench (up to 40Nm).               <ul style="list-style-type: none"> <li>• Jack and block of wood.</li> </ul> </li> </ul>	<p>M4 BOLT = 8Nm</p> <p>M5 BOLT = 12Nm</p> <p>M6 BOLT = 15Nm</p> <p>M8 BOLT = 20Nm</p> <p>M10 BOLT = 40Nm</p> <p>M12 BOLT = 40Nm</p>

### **LEGEND**

<b>ITEM No.</b>	<b>DESCRIPTION</b>	<b>QTY</b>
ITEM 1	AB0061 LEFT HAND SIDE ADVENTURE BAR	1
ITEM 2	M8 WASHERS	4
ITEM 3	M8x20mm LONG BUTTON HEAD BOLTS	2
ITEM 4	M6x40mm LONG CAP HEAD BOLTS	4
ITEM 5	M6 CAP HEAD BOLT SPACERS (S1275)	4
ITEM 6	M6 FLAT CAPS (NC0008)	4
ITEM 7	M6 DOMED LOCKING NUTS	4
ITEM 8	AB0061 RIGHT HAND SIDE ADVENTURE BAR	1
ITEM 9	M8x50mm LONG BUTTON HEAD BOLT	1
ITEM 10	M8 FLANGED LOCKING NUT	1

R&G

Unit 1, Shelley's Lane, East Worldham, Alton, Hampshire, GU34 3AQ

Tel: +44 (0)1420 89007 Fax: +44 (0)1420 87301 [www.rg-racing.com](http://www.rg-racing.com) Email: [info@rg-racing.com](mailto:info@rg-racing.com)

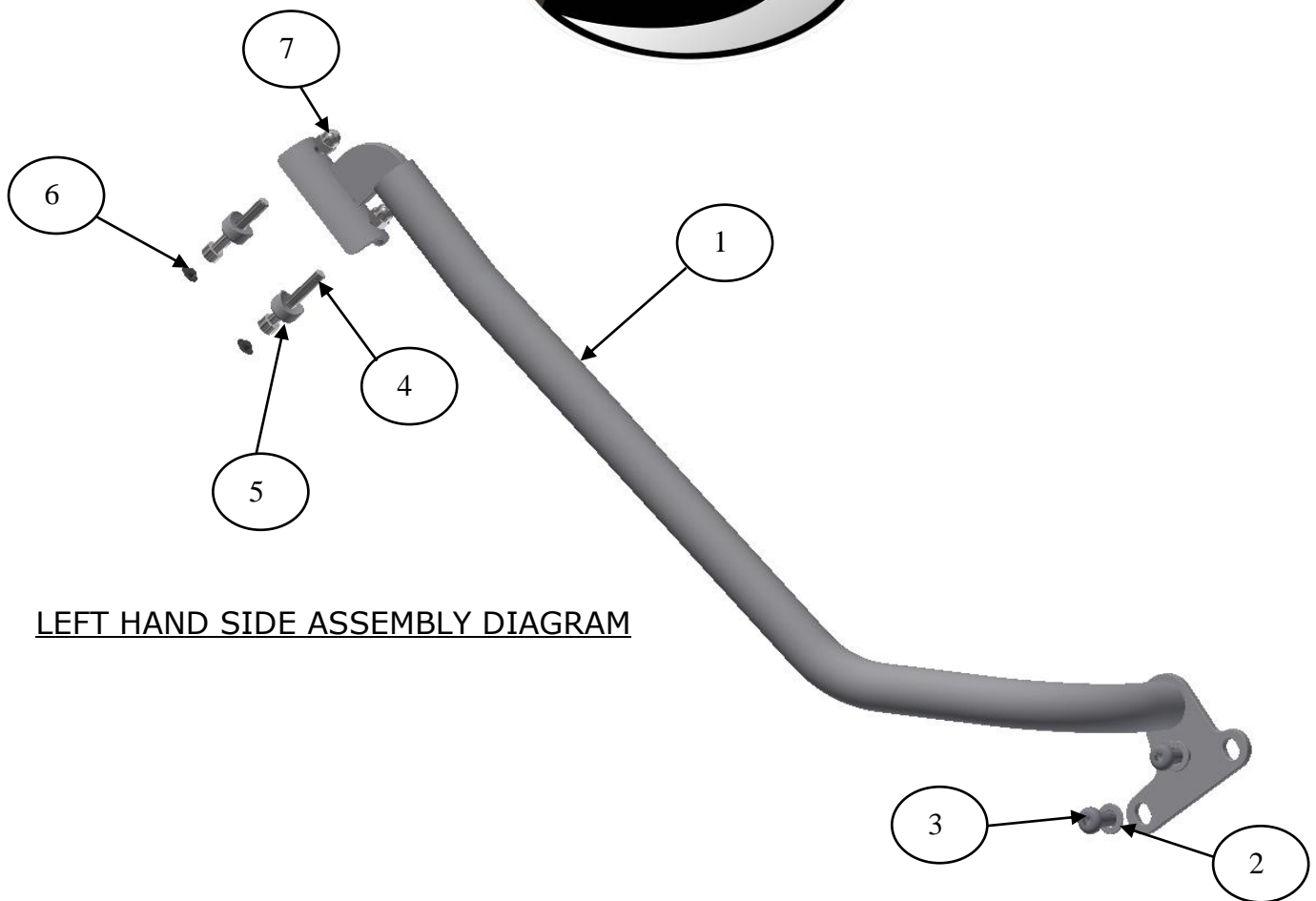

LEFT HAND SIDE ASSEMBLY DIAGRAM

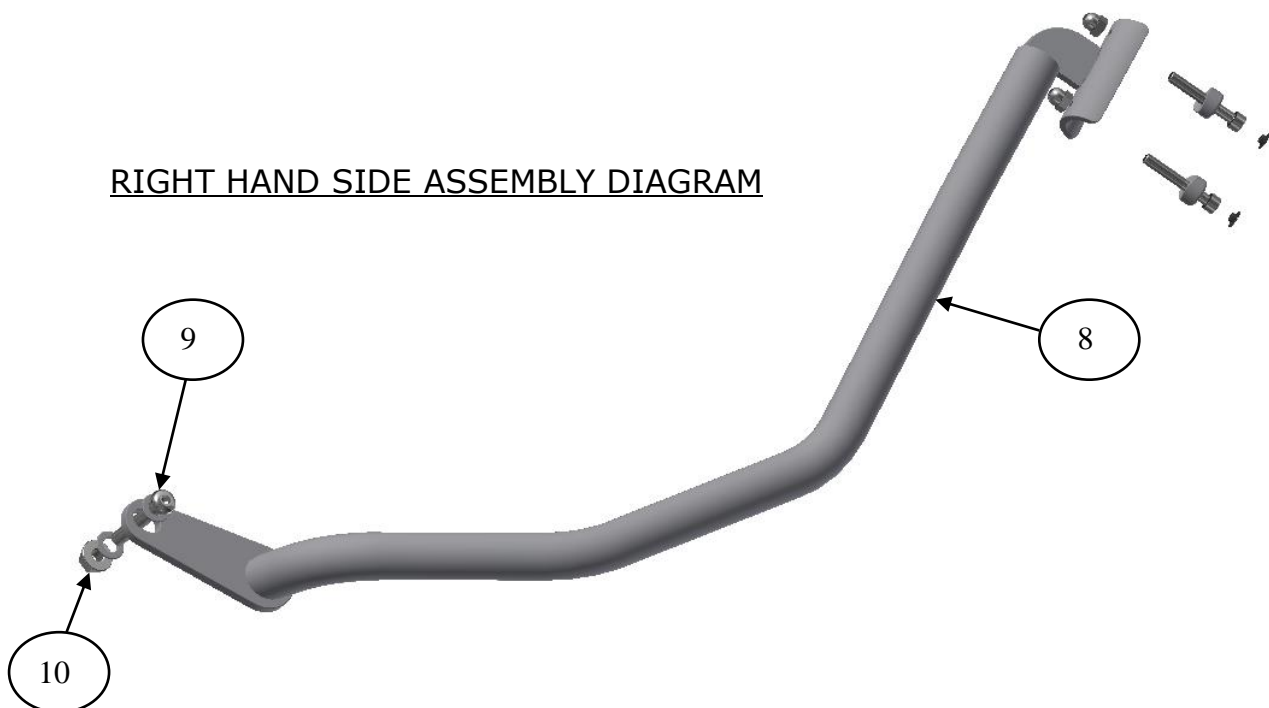

RIGHT HAND SIDE ASSEMBLY DIAGRAM

**ASSEMBLY DIAGRAMS**



Picture 1

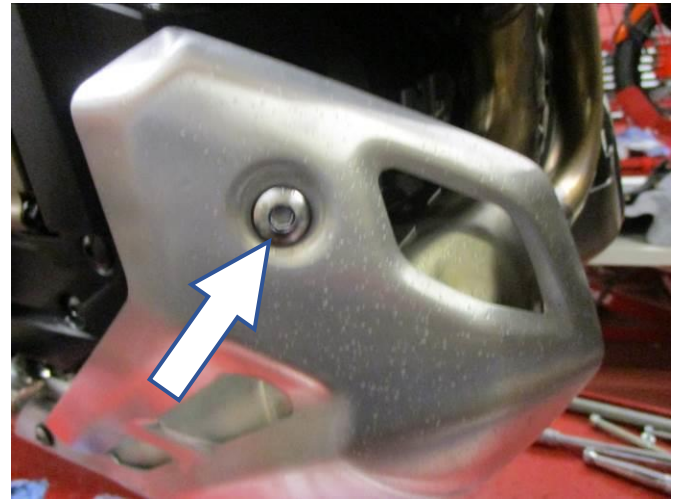

Picture 2



Picture 3



Picture 4



Picture 5



Picture 6

R&G

Unit 1, Shelley's Lane, East Worldham, Alton, Hampshire, GU34 3AQ

Tel: +44 (0)1420 89007 Fax: +44 (0)1420 87301 [www.rg-racing.com](http://www.rg-racing.com) Email: [info@rg-racing.com](mailto:info@rg-racing.com)

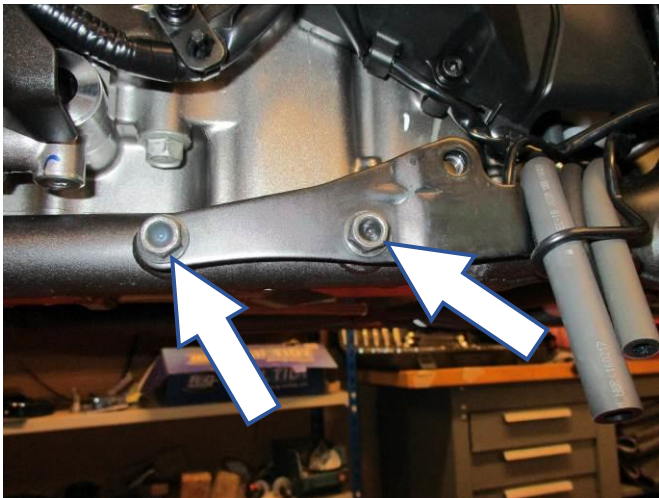

Picture 7

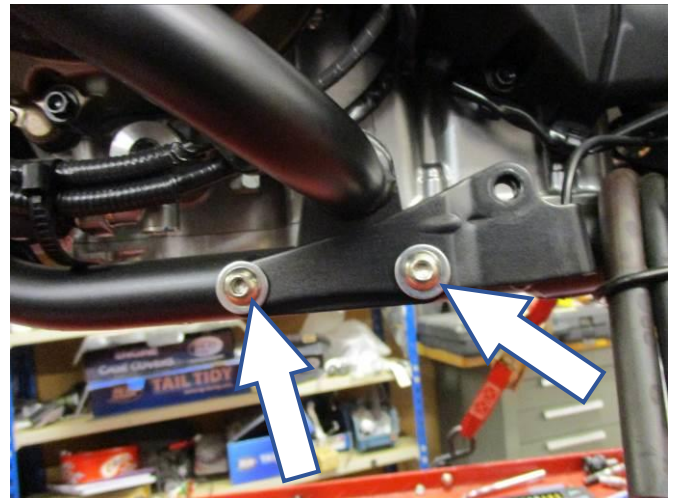

Picture 8

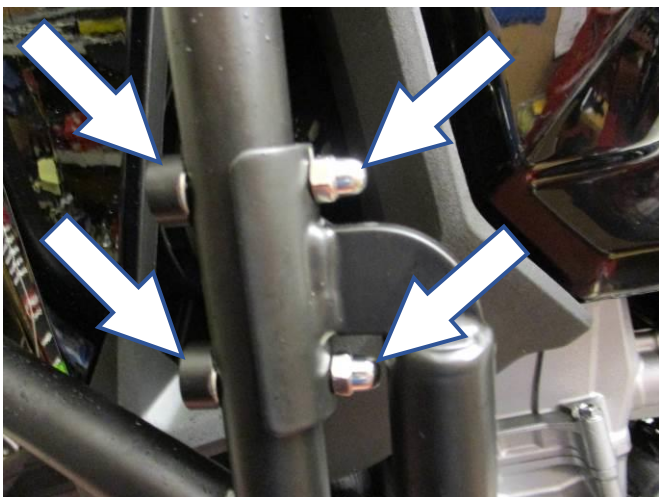

Picture 9



Picture 10

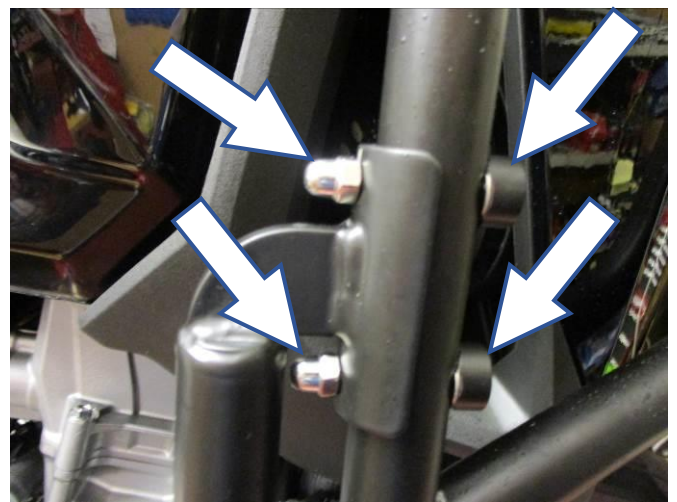
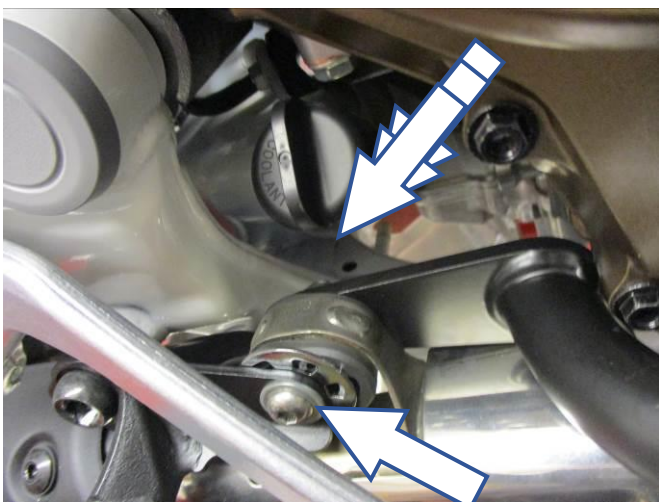

R&G



Picture 11

Picture 12

## **FITTING INSTRUCTIONS**

### **Removal of original sump-guard/bash plate**

- Remove the eight bolts arrowed in **pictures 1, 2, 3, 4 and 5** while supporting the bash plate.
- Gently lower the bash plate and remove from the location peg as shown in **picture 6** and remove the bash plate.
- Then support the engine with a jack and block of wood to prevent engine movement.
- Remove the rubber grommets from both sides of AB0060.

### **Near side (left side as you sit on bike)**

- Remove the two bolts arrowed in **picture 7**.
- Offer the left-hand side adventure bar (**item 1**) into position as shown in **pictures 8 and 9 (also the top left hand picture)**.
- Secure the lower bracket as shown in **picture 8** using the two M8 bolts with washers (**items 2 and 3**) do not tighten at this stage.
- Place two of the cap head bolt spacers onto two of the M6 bolts (**items 4 and 5**), then engage the bolts through the upper adventure bar and into the upper mounting bracket of the lower adventure bars as shown in **picture 9** the upper bolt can be fully engaged but the domed nut (**item 7**) must be engaged onto the lower bolts before tightening, then one of the remaining nuts can be tightened onto the upper bolt as shown in **picture 9**.
- Tighten the two lower bolts.
- Conceal the bolt heads using the flat caps (**item 6**).

### **Off side (right side as you sit on bike)**

- **Remove the nut arrowed in picture 10 and remove the bolt from inboard of the frame.**
- Offer the right-hand side adventure bar (**item 8**) into position as shown in **pictures 11 and 12 (also the top right hand picture)**.
- Secure the lower bracket as shown in **picture 11** using the longer M8 bolt with washer (**items 2 and 9**) and a washer and the M8 flange nut (**items 2 and 10**) do not tighten at this stage.
- Place two of the cap head bolt spacers onto two of the M6 bolts (**items 4 and 5**), then engage the bolts through the upper adventure bar and into the upper mounting bracket of the lower adventure bars as shown in **picture 12** the upper bolt can be fully engaged but the domed nut (**item 7**) must be engaged onto the lower bolts before tightening, then one of the remaining nuts can be tightened onto the upper bolt as shown in **picture 12**.
- Tighten the lower nut and bolt.
- Conceal the bolt heads using the flat caps (**item 6**).

ISSUE 1 06/04/2021 (NSY)

### **CONSUMER NOTICE**

The catalogue description and any exhibition of samples are only broad indications of the Products and R&G may make design changes which do not diminish their performance or visual appeal and supplying them in such state shall conform to the order. The Buyer acknowledges no representation or warranty (other than as to title) has been given or will apply to the Products other than those in R&G's order or confirmation and the Buyer confirms it has chosen the Products as being of merchantable quality and suitable for its particular purposes. Where R&G fits the Products or undertakes other services it shall exercise reasonable skill and care and rectify any fault free of charge unless the workmanship has been disturbed. The Buyer is responsible for ensuring that the warranty on the motorcycle is not affected by the fitting of the Products. On return of any defective Products R&G shall at its option either supply a replacement or refund the purchase money but shall not be liable if the Products have been modified or used or maintained otherwise than in accordance with R&G's or manufacturer's instructions and good engineering practice or if the defect arises from accident or neglect. Other than identified above and subject to R&G not limiting its liability for causing death and personal injury, it shall not be liable for indirect or consequential loss and otherwise its liability

R&amp;G

Unit 1, Shelley's Lane, East Worldham, Alton, Hampshire, GU34 3AQ

Tel: +44 (0)1420 89007 Fax: +44 (0)1420 87301 [www.rg-racing.com](http://www.rg-racing.com) Email: [info@rg-racing.com](mailto:info@rg-racing.com)



shall be limited to the amounts paid by the Buyer for the Products or the fitting or service concerned. These terms do not affect the Buyer's statutory rights.

**R&G RACING RETURNS POLICY (NON-FAULTY GOODS)**

Returns must be pre-authorized (if not pre-authorized the return will be rejected). Goods may only be returned direct to us if they were purchased direct from us (customer must prove if necessary). Otherwise to be returned to original vendor. Goods must be in re-sellable condition, in the opinion of R&G Racing. All returns are subject to a 25% restocking and handling fee (25% of the gross value exc. P&P – at the prevailing price at time of purchase). The customer must pay any and all carriage charges. No returns of discontinued products, unless within 14 days of purchase. This policy does not affect your statutory rights and does not refer to faulty goods.

R&G

Unit 1, Shelley's Lane, East Worldham, Alton, Hampshire, GU34 3AQ

Tel: +44 (0)1420 89007 Fax: +44 (0)1420 87301 [www.rg-racing.com](http://www.rg-racing.com) Email: [info@rg-racing.com](mailto:info@rg-racing.com)



**NOTICE DE MONTAGE AB0061 BARRES AVENTURE INFÉRIEURES  
HONDA AFRICA TWIN ADVENTURE SPORTS DCT/NON DCT 2020-  
PEUT UNIQUEMENT ÊTRE MONTÉ EN AVEC LES BARRES SUPÉRIEURES D'ADVENTURE AB0060**



**CE KIT CONTIENT LES ARTICLES ILLUSTRÉS ET ÉTIQUETES SUR LA PAGE.**

CERTAINES PARTIES PEUVENT ÊTRE PRÉSENTES UNIQUEMENT POUR LA CLARTÉ DES INSTRUCTIONS.

NE PAS PROCÉDER AU MONTAGE TANT QUE VOUS N'ÊTES PAS SÛR QUE TOUTES LES PIÈCES SOIENT PRÉSENTES.

**VEUILLEZ LIRE TOUTES LES INSTRUCTIONS AVANT DE CONTINUER.**

**EN CAS DE DOUTE LORS DU MONTAGE DE NOS PRODUITS, CONSULTEZ UN DE NOS REVENDEURS OU FAITES APPEL À UN TECHNICIEN QUALIFIÉ.**

VEUILLEZ NOTER QUE LA FAÇON DONT LE KIT EST EMBALLÉ NE REPRÉSENTE PAS NECESSAIREMENT LA MANIÈRE DE LE MONTER SUR LA MOTO.

SI DES RONDELLES EN CAOUTCHOUC SONT UTILISÉES POUR MAINTENIR LES COMPOSANTS SUR LES BOULONS, ELLES PEUVENT ÊTRE JETÉES.

**NOTICE DISPONIBLE AU TÉLÉCHARGEMENT SUR : [WWW.RG-RACING.COM](http://WWW.RG-RACING.COM)**

R&G

Unit 1, Shelley's Lane, East Worldham, Alton, Hampshire, GU34 3AQ  
Tel: +44 (0)1420 89007 Fax: +44 (0)1420 87301 [www.rg-racing.com](http://www.rg-racing.com) Email: [info@rg-racing.com](mailto:info@rg-racing.com)





<b>OUTILS REQUIS</b>	<b>VALEURS DE SERRAGE</b>
<ul style="list-style-type: none"> <li>• Clés Allen 4, 5 &amp; 6mm.</li> <li>• Clé à cliquet + douilles 10, 12, 13, 14 &amp; 17mm.</li> <li>• Clé dynamométrique (à 40Nm).               <ul style="list-style-type: none"> <li>• Prise et bloc de bois.</li> </ul> </li> </ul>	<p>M4 BOULON = 8Nm</p> <p>M5 BOULON = 12Nm</p> <p>M6 BOULON = 15Nm</p> <p>M8 BOULON = 20Nm</p> <p>M10 BOULON = 40Nm</p> <p>M12 BOULON = 40Nm</p>

### **LÉGENDE**

<b>ARTICLE No.</b>	<b>DESCRIPTION</b>	<b>QTÉ</b>
ARTICLE 1	AB0061 BARRE AVENTURE CÔTÉ GAUCHE	1
ARTICLE 2	M8 RONDELLES	4
ARTICLE 3	M8x20mm BOULONS	2
ARTICLE 4	M6x40mm BOULONS	4
ARTICLE 5	M6 ENTRETOISES (S1275)	4
ARTICLE 6	M6 CAPUCHONS PLATS (NC0008)	4
ARTICLE 7	M6 ÉCROUS DE BLOCAGE	4
ARTICLE 8	AB0061 BARRE AVENTURE CÔTÉ DROIT	1
ARTICLE 9	M8x50mm BOULON	1
ARTICLE 10	M8 ÉCROU DE BLOCAGE	1

R&G

Unit 1, Shelley's Lane, East Worldham, Alton, Hampshire, GU34 3AQ

Tel: +44 (0)1420 89007 Fax: +44 (0)1420 87301 [www.rg-racing.com](http://www.rg-racing.com) Email: [info@rg-racing.com](mailto:info@rg-racing.com)



SCHÉMA CÔTÉ GAUCHE



SCHÉMA CÔTÉ DROIT

**SCHÉMAS D'ENSEMBLE**

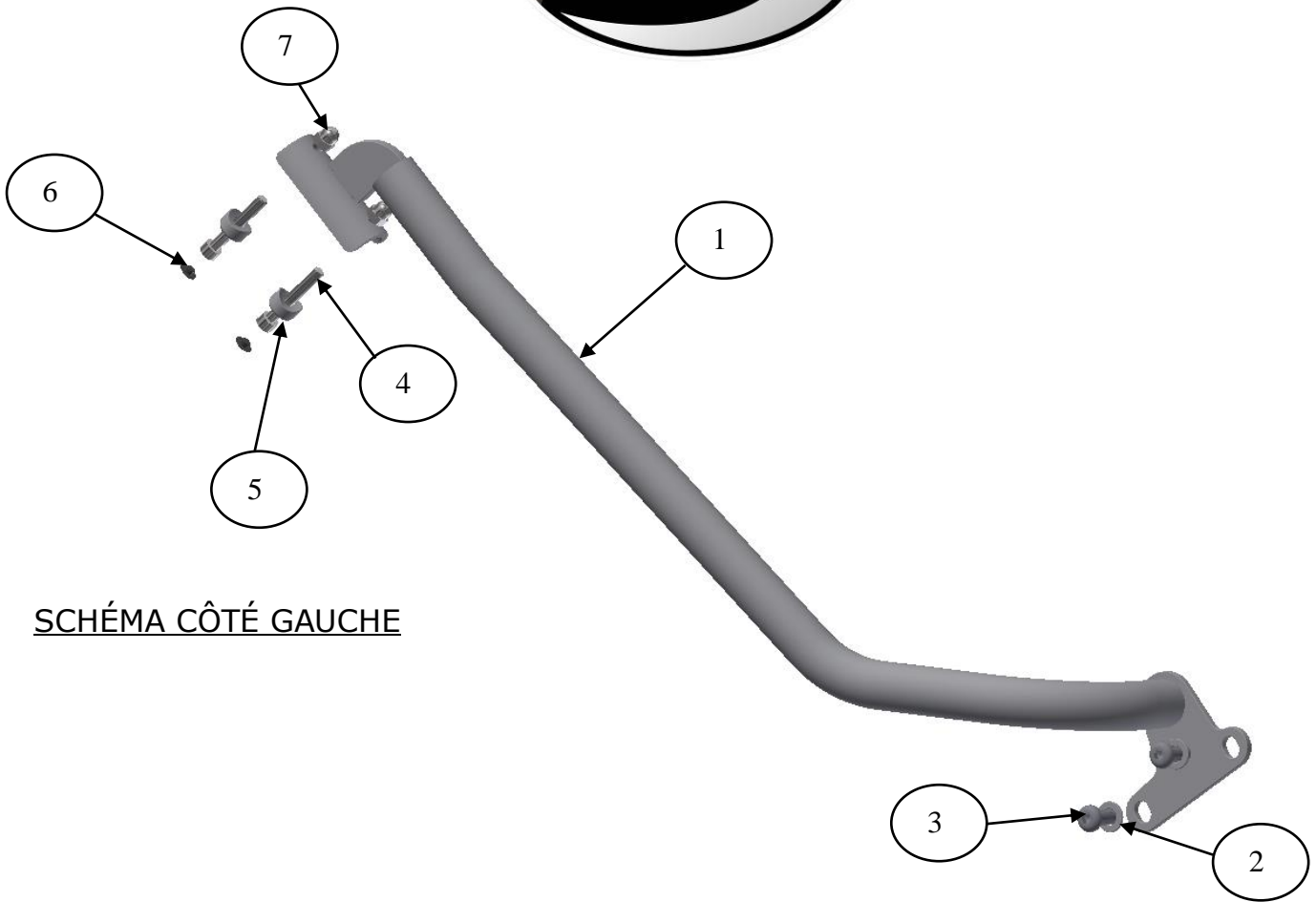

Photo 1

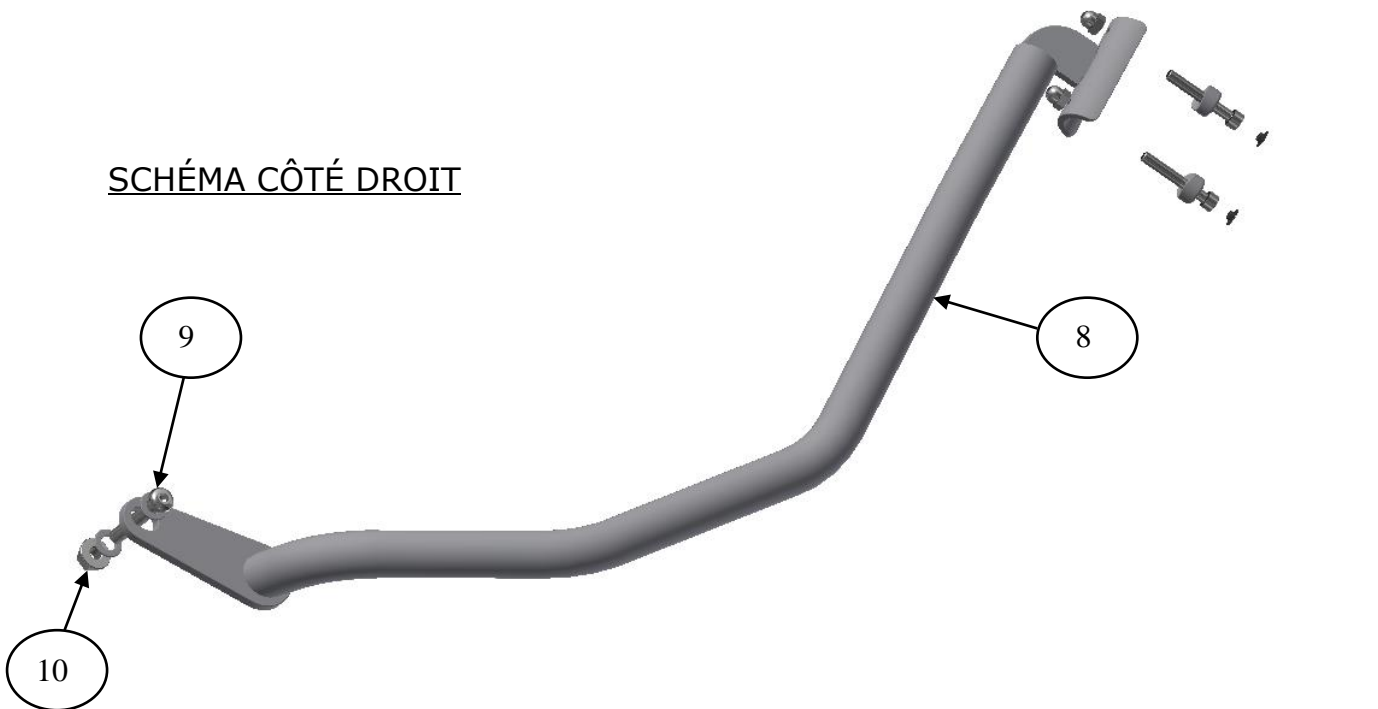
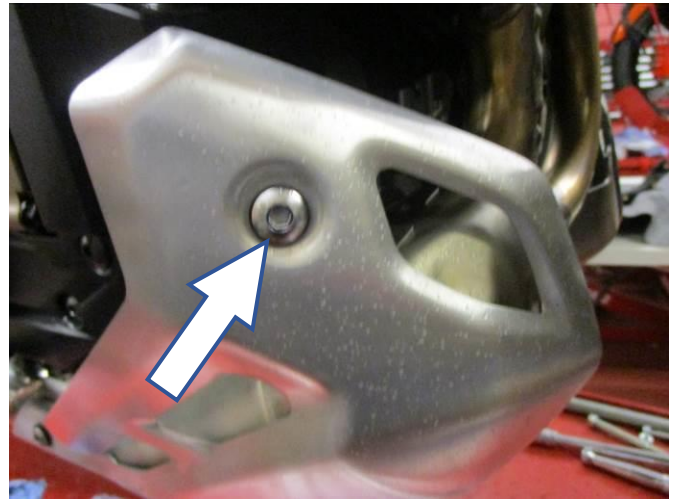

Photo 2



Photo 3



Photo 4



Photo 5



Photo 6

R&G

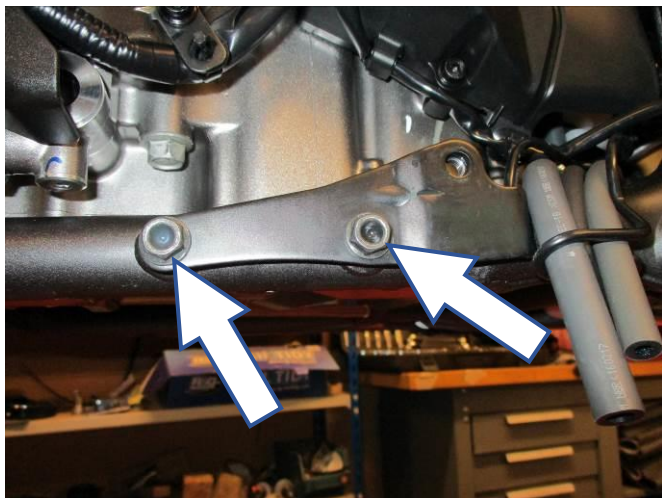

Photo 7

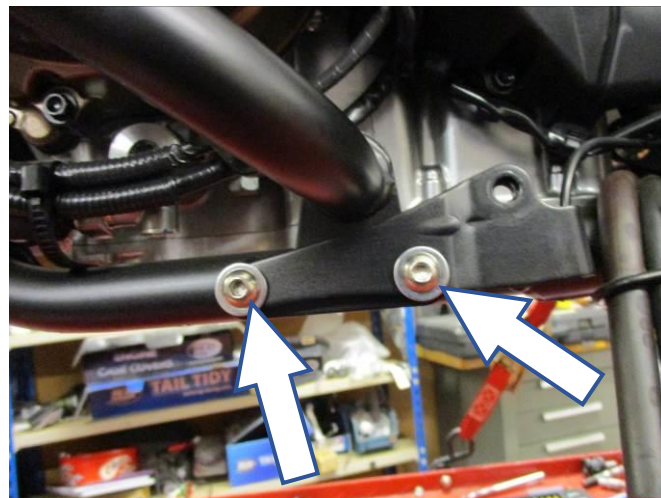

Photo 8

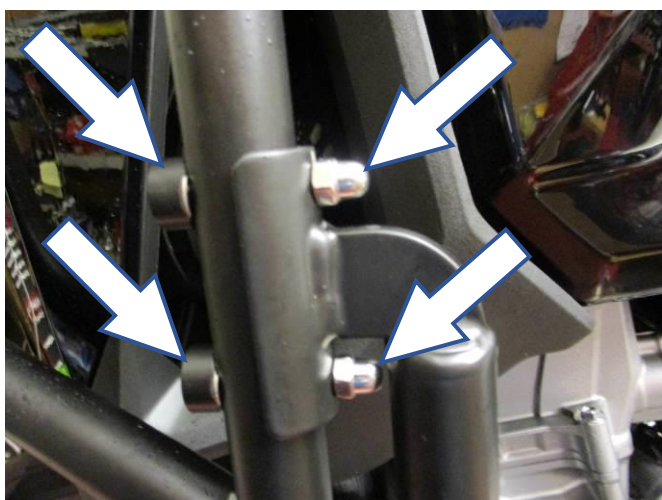

Photo 9

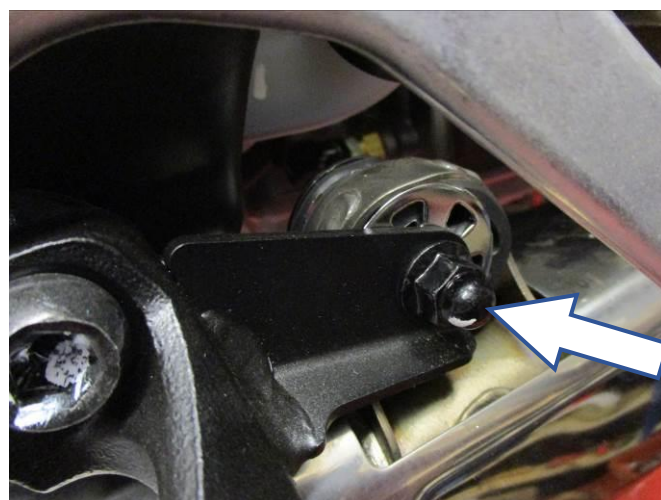

Photo 10

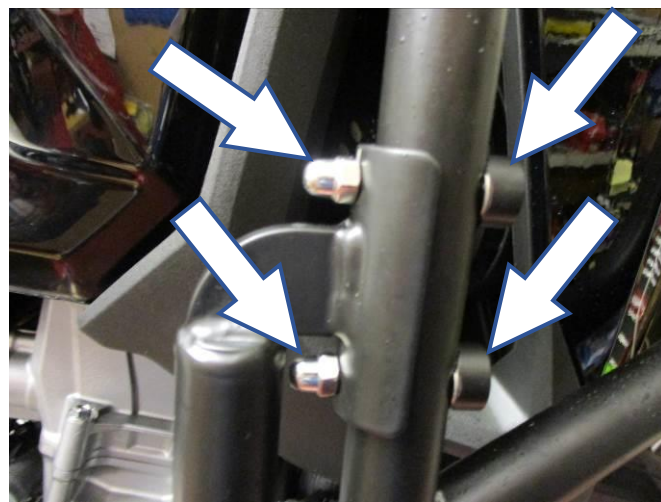
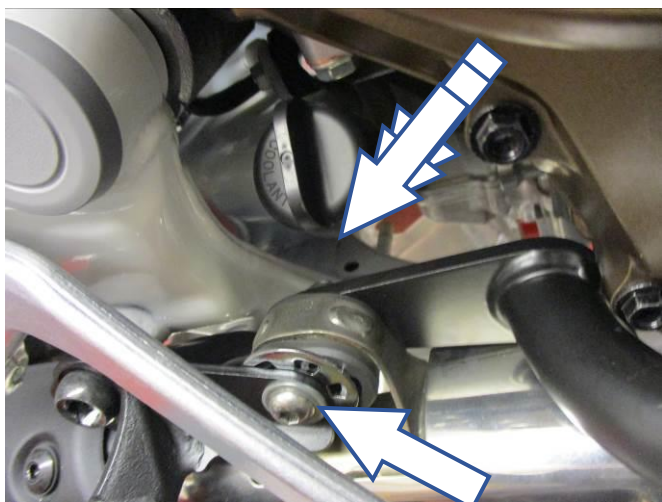



Photo 11

Photo 12

## **NOTICE DE MONTAGE**

### **Retrait du carter de protection / plaque anti projection**

- Retirez les huit boulons marqués d'une flèche sur les photos 1, 2, 3, 4 et 5 tout en soutenant la plaque de base.
- Abaissez doucement la plaque anti projections et retirez-la de la cheville de positionnement comme indiqué sur la photo 6 et retirez la plaque.
- Soutenez ensuite le moteur avec un cric et un bloc de bois pour empêcher tout mouvement du moteur.
- Retirez les œillets en caoutchouc des deux côtés de l'AB0060.

### **Côté gauche (lorsqu'on est assis sur la moto)**

- Retirez les deux boulons indiqués sur la photo 7.
- Présentez la barre d'aventure de gauche (article 1) en position comme indiqué sur les photos 8 et 9 (également la photo en haut à gauche).
- Fixez le support inférieur comme indiqué sur la photo 8 à l'aide des deux boulons M8 avec rondelles (articles 2 et 3) ne serrez pas à ce stade.
- Placez deux des entretoises de boulon à tête cylindrique sur deux des boulons M6 (articles 4 et 5), puis engagez les boulons à travers la barre d'aventure supérieure et dans le support de montage supérieur des barres d'aventure inférieures comme indiqué sur la photo 9 le boulon supérieur peut être complètement engagé mais l'écrou bombé (article 7) doit être engagé sur les boulons inférieurs avant le serrage, puis l'un des écrous restants peut être serré sur le boulon supérieur comme indiqué sur la photo 9.
- Serrez les deux boulons inférieurs.
- Cachez les têtes de boulons à l'aide des capuchons plats (article 6).

### **Côté droit (lorsqu'on est assis sur la moto)**

- Retirez l'écrou marqué d'une flèche sur la photo 10 et retirez le boulon de l'intérieur du cadre.
- Présentez la barre d'aventure côté droit (article 8) en position comme indiqué sur les photos 11 et 12 (également la photo en haut à droite).
- Fixez le support inférieur comme indiqué sur la photo 11 à l'aide du boulon M8 plus long avec rondelle (articles 2 et 9) et une rondelle et l'écrou de bride M8 (articles 2 et 10) ne serrez pas à ce stade.
- Placez deux des entretoises de boulon à tête cylindrique sur deux des boulons M6 (articles 4 et 5), puis engagez les boulons à travers la barre d'aventure supérieure et dans le support de montage supérieur des barres d'aventure inférieures comme indiqué sur la photo 12 le boulon supérieur peut être complètement engagé mais l'écrou bombé (article 7) doit être engagé sur les boulons inférieurs avant le serrage, puis l'un des écrous restants peut être serré sur le boulon supérieur comme indiqué sur la photo 12.
- Serrez l'écrou et le boulon inférieurs.
- Cachez les têtes de boulons à l'aide des capuchons plats (article 6).

ISSUE 1 06/04/2021 (NSY)

#### **CONSUMER NOTICE**

The catalogue description and any exhibition of samples are only broad indications of the Products and R&G may make design changes which do not diminish their performance or visual appeal and supplying them in such state shall conform to the order. The Buyer acknowledges no representation or warranty (other than as to title) has been given or will apply to the Products other than those in R&G's order or confirmation and the Buyer confirms it has chosen the Products as being of merchantable quality and suitable for its particular purposes. Where R&G fits the Products or undertakes other services it shall exercise reasonable skill and care and rectify any fault free of charge unless the workmanship has been disturbed. The Buyer is responsible for

R&amp;G

Unit 1, Shelley's Lane, East Worldham, Alton, Hampshire, GU34 3AQ

Tel: +44 (0)1420 89007 Fax: +44 (0)1420 87301 [www.rg-racing.com](http://www.rg-racing.com) Email: [info@rg-racing.com](mailto:info@rg-racing.com)



ensuring that the warranty on the motorcycle is not affected by the fitting of the Products. On return of any defective Products R&G shall at its option either supply a replacement or refund the purchase money but shall not be liable if the Products have been modified or used or maintained otherwise than in accordance with R&G's or manufacturer's instructions and good engineering practice or if the defect arises from accident or neglect. Other than identified above and subject to R&G not limiting its liability for causing death and personal injury, it shall not be liable for indirect or consequential loss and otherwise its liability shall be limited to the amounts paid by the Buyer for the Products or the fitting or service concerned. These terms do not affect the Buyer's statutory rights.

**R&G RACING RETURNS POLICY (NON-FAULTY GOODS)**

Returns must be pre-authorized (if not pre-authorized the return will be rejected). Goods may only be returned direct to us if they were purchased direct from us (customer must prove if necessary). Otherwise to be returned to original vendor. Goods must be in re-sellable condition, in the opinion of R&G Racing. All returns are subject to a 25% restocking and handling fee (25% of the gross value exc. P&P – at the prevailing price at time of purchase). The customer must pay any and all carriage charges. No returns of discontinued products, unless within 14 days of purchase. This policy does not affect your statutory rights and does not refer to faulty goods.

R&G

Unit 1, Shelley's Lane, East Worldham, Alton, Hampshire, GU34 3AQ

Tel: +44 (0)1420 89007 Fax: +44 (0)1420 87301 [www.rg-racing.com](http://www.rg-racing.com) Email: [info@rg-racing.com](mailto:info@rg-racing.com)



**MONTAGEANLEITUNG FÜR DEN AB0061 UNTERER ADVENTURE-STURZBÜGEL**  
**HONDA AFRICA TWIN ADVENTURE SPORTS DCT/NON DCT 2020-**  
**BITTE BEACHTEN SIE, DASS DIESE TEILE NUR ANGEBAUT WERDEN KÖNNEN, WENN DER**  
**AB0060 OBERE ADVENTURE BAR - STURZBÜGEL BEREITS MONTIERT SIND**



**Alle Kit-Teile sind auf den nachfolgenden Seiten abgebildet und gekennzeichnet.**

**Die abgebildeten Teile dienen lediglich zur Erklärung.**

**Überprüfen Sie zuerst, dass alle Teile vorhanden sind.**

**Lesen Sie die Montageanleitung komplett durch, bevor Sie anfangen.**

**WENN SIE BEI DER MONTAGE DIESES PRODUKTES UNSICHER SIND, BITTE EINEN**  
**UNSERER HÄNDLER KONTAKTIEREN ODER DAS KIT VON EINEM QUALIFIZIERTEN**  
**ZWEIRAD-MECHANIKER MONTIEREN LASSEN.**

Die Verpackung der Teile stellt nicht die Reihenfolge der Montage dar.

**EINE DIGITALE VERSION DIESER MONTAGEANLEITUNG KANN AUF**  
**FOLGENDER SEITE HERUNTERGELADEN WERDEN:**  
**[WWW.RG-RACING.COM](http://WWW.RG-RACING.COM)**

R&G

Unit 1, Shelley's Lane, East Worldham, Alton, Hampshire, GU34 3AQ  
Tel: +44 (0)1420 89007 Fax: +44 (0)1420 87301 [www.rg-racing.com](http://www.rg-racing.com) Email: [info@rg-racing.com](mailto:info@rg-racing.com)



<b>SIE BENÖTIGEN FOLGENDES WERKZEUG:</b>	<b>ALLGEM. ANZUGSDREHMOMENT</b>
<ul style="list-style-type: none"> <li>• Satz Inbusschlüssel inkl. 4,5 &amp; 6mm</li> <li>• Satz Steckschlüssel inkl. 10, 12, 13, 14 &amp; 17mm</li> <li>• Drehmomentschlüssel (bis 40Nm)               <ul style="list-style-type: none"> <li>• Heber oder ähnliches, um das Motorrad zu stützen                   <ul style="list-style-type: none"> <li>• Holzblock</li> </ul> </li> </ul> </li> </ul>	<p>M4 SCHRAUBE = 8Nm            M5 SCHRAUBE = 12Nm            M6 SCHRAUBE = 15Nm            M8 SCHRAUBE = 20Nm            M10 SCHRAUBE = 40Nm            M12 SCHRAUBE = 40Nm</p>

### **LIEFERUMFANG**

<b>ARTIKEL NR.</b>	<b>BESCHREIBUNG</b>	<b>MENGE</b>
ARTIKEL 1	AB0061 LINKE SEITE ADVENTURE BAR-STURZBÜGEL	1
ARTIKEL 2	M8 UNTERLEGSCHIEBE	4
ARTIKEL 3	M8x20mm INBUSSCHRAUBE	2
ARTIKEL 4	M6x40mm INNENSECHSKANTSCHRAUBE	4
ARTIKEL 5	DISTANZHALTER FÜR M6 SCHRAUBEN (S1275)	4
ARTIKEL 6	M6 FLACHE KAPPE (NC0008)	4
ARTIKEL 7	M6 SICHERUNGSMUTTER (HUTMUTTER)	4
ARTIKEL 8	AB0061 RECHTE SEITE ADVENTURE BAR- STURZBÜGEL	1
ARTIKEL 9	M8x50mm INBUSSCHRAUBE	1
ARTIKEL 10	M8 FLANSCHMUTTER	1

R&G

Unit 1, Shelley's Lane, East Worldham, Alton, Hampshire, GU34 3AQ

Tel: +44 (0)1420 89007 Fax: +44 (0)1420 87301 [www.rg-racing.com](http://www.rg-racing.com) Email: [info@rg-racing.com](mailto:info@rg-racing.com)



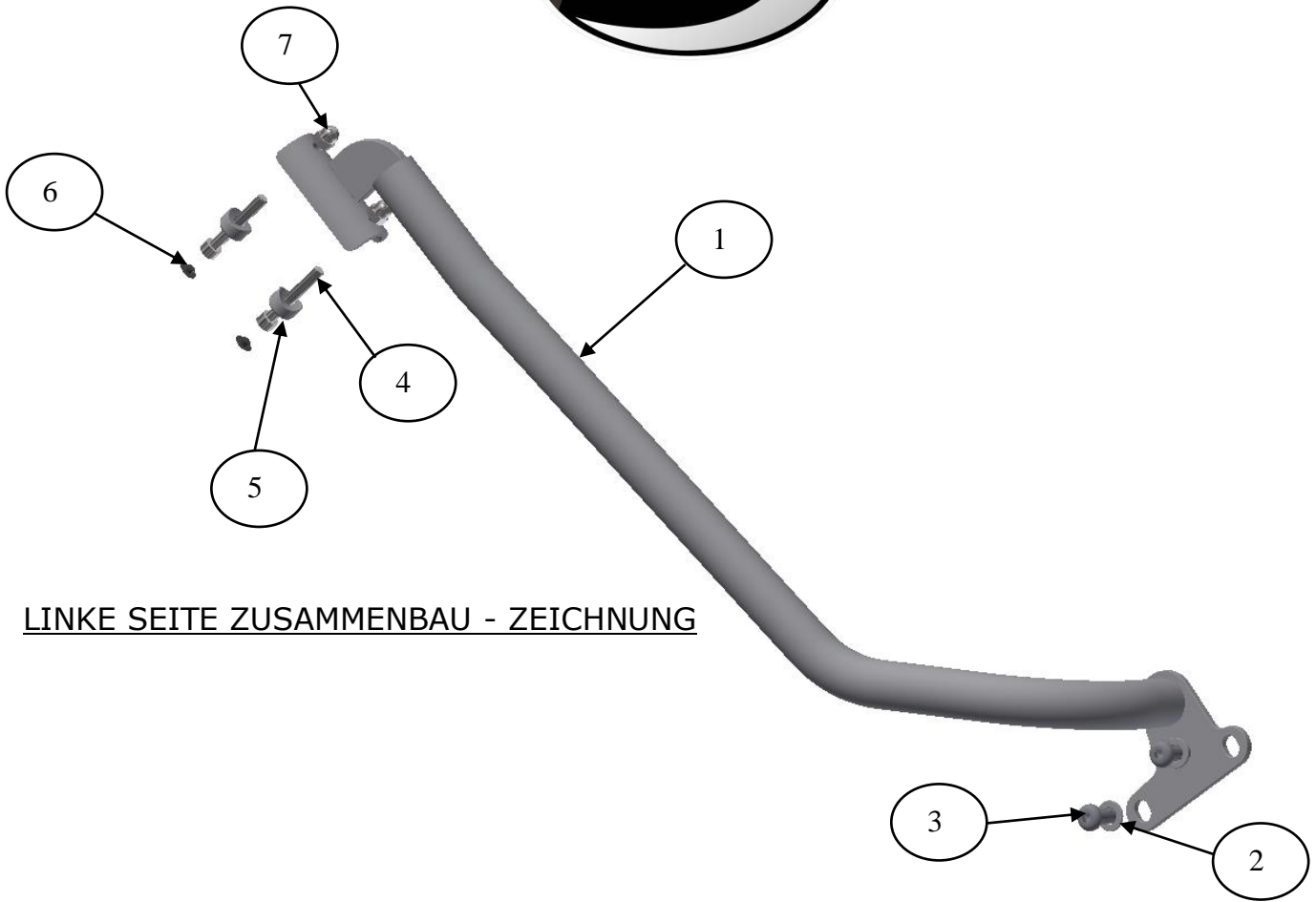

LINKE SEITE ZUSAMMENBAU - ZEICHNUNG

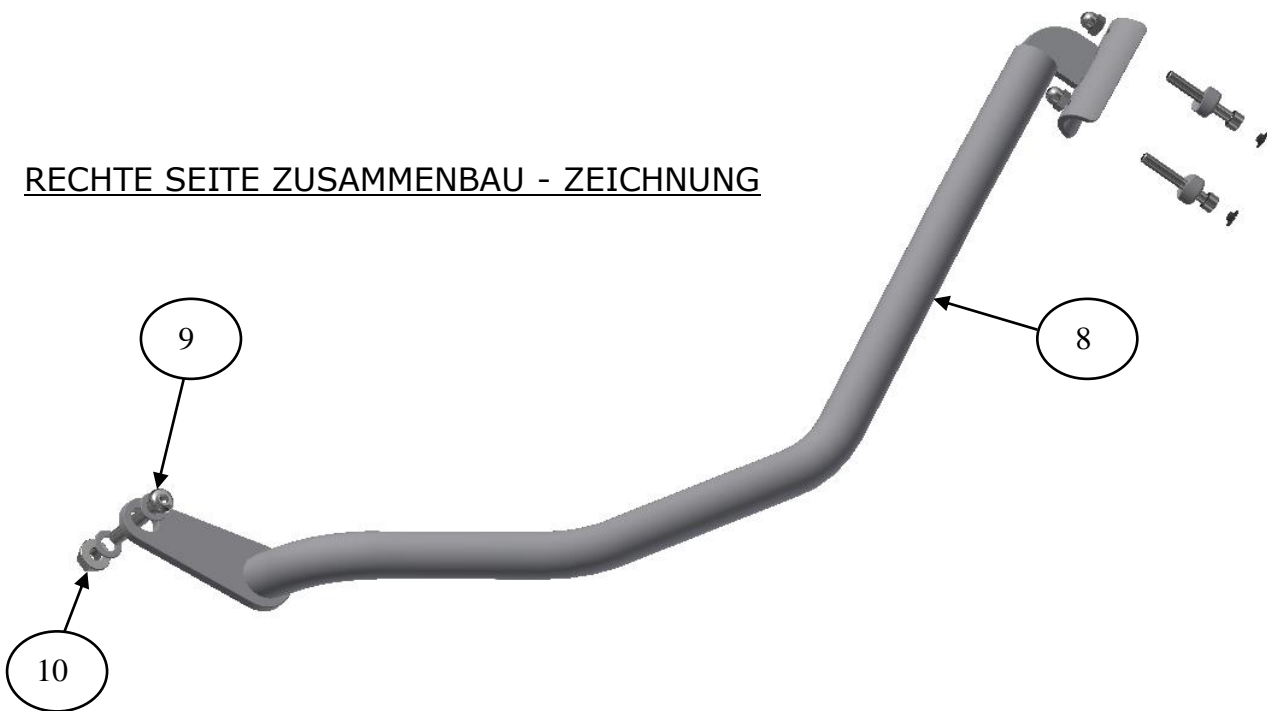

RECHTE SEITE ZUSAMMENBAU - ZEICHNUNG

**ZUSAMMENBAU - ZEICHNUNGEN**

R&G



Abbildung 1



Abbildung 2

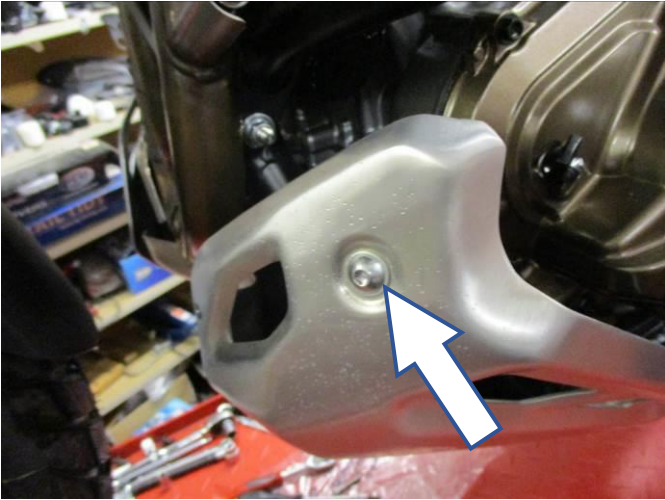

Abbildung 3



Abbildung 4



Abbildung 5



Abbildung 6

R&G



Abbildung 7



Abbildung 8

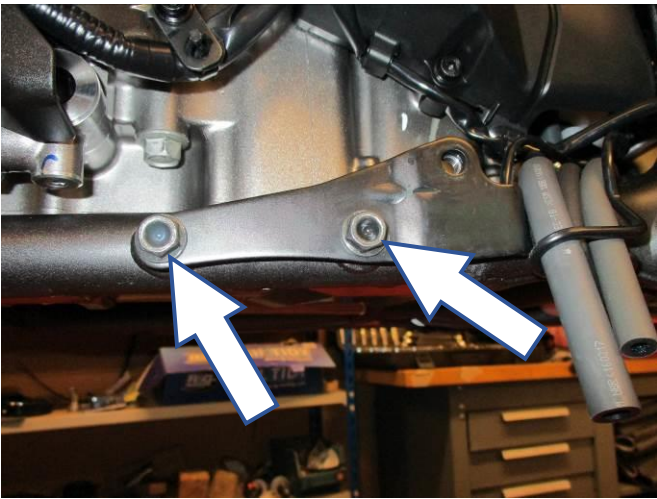

Abbildung 9

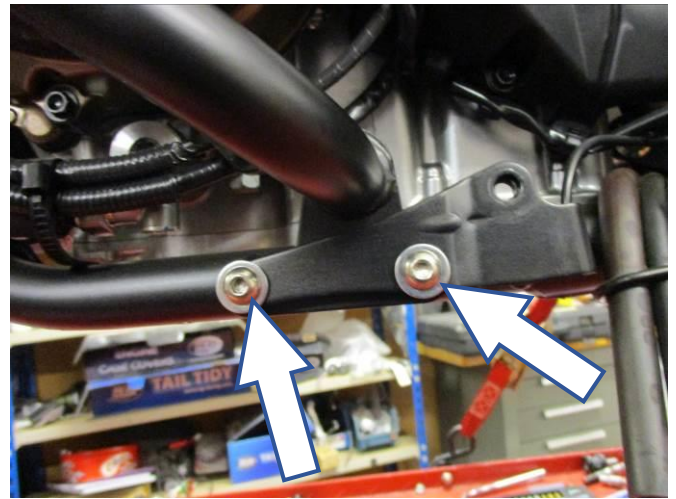

Abbildung 10

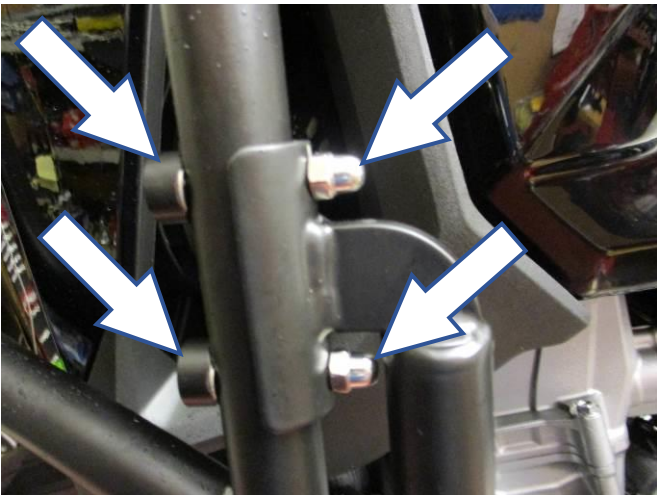

Abbildung 11

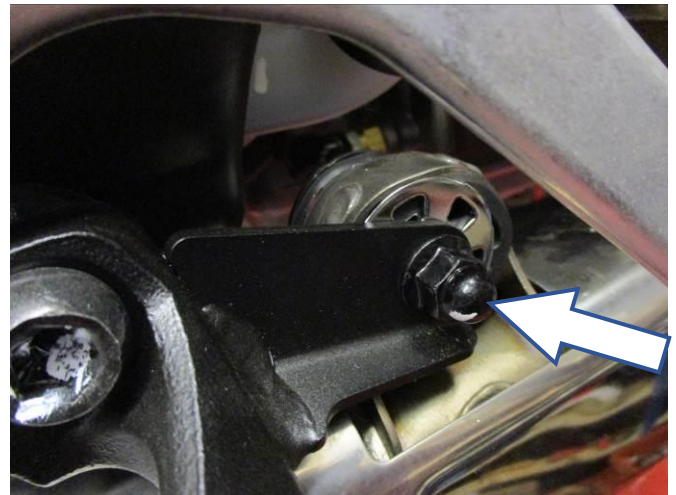

Abbildung 12

R&G

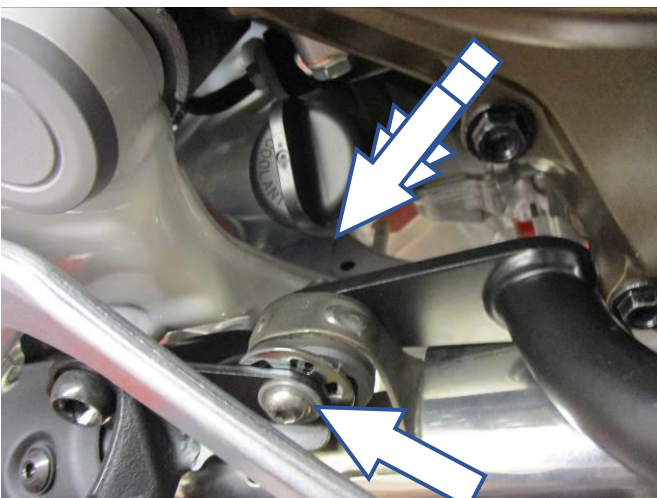

## **MONTAGEANLEITUNG**

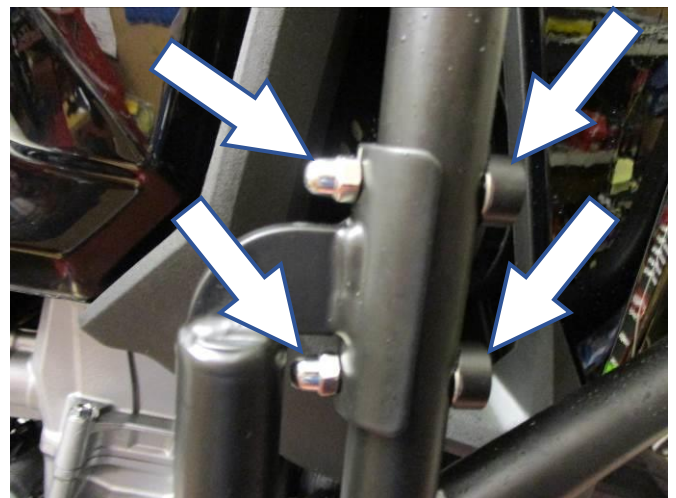
### **Entfernung des original Ölwannenschutz/Motorschutz**

- Entfernen Sie die acht Schrauben, die in den **Abbildungen 1,2, 3, 4 und 5** gekennzeichnet sind – stützen Sie dabei den Motorschutz.
- Den Motorschutz herabsetzen und vom Fixierstift lösen, wie in **Abbildung 6** abgebildet. Den Motorschutz entfernen.
- Den Motor mit einem Heber oder einem Holzblock stützen, um zu verhindern, dass der Motor sich während der Montage bewegt.
- Entfernen Sie die Gummitüllen an beiden Seiten von AB0060.

### **Linke Seite (in Fahrtrichtung)**

- Entfernen Sie die zwei Schrauben, die in **Abbildung 7** mit Pfeilen markiert sind.
- Den Adventure-Sturzbügel für die linke Seite (**Artikel 1**) in Position bringen wie in den **Abbildungen 8 und 9** abgebildet (siehe auch Abbildung für die linke Seite oben).
- Die untere Halterung sichern wie in **Abbildung 8** abgebildet mit den zwei M8 Schrauben und Unterlegscheiben (**Artikel 2 und 3**) - zu diesem Zeitpunkt nicht festziehen.
- Die zwei Distanzhalter an den M6 Schrauben (**Artikel 4 and 5**) montieren. Die Schrauben durch den oberen Adventure Bar-Sturzbügel in die obere Montagehalterung des unteren Adventure Bar-Sturzbügel einführen wie in **Abbildung 9** abgebildet. Die obere Schraube kann komplett eingeschraubt sein, aber die Hutmutter (**Artikel 7**) muss an den unteren Schrauben eingerastet sein, bevor sie festgezogen werden kann. Die übrige Mutter kann dann an der oberen Schraube befestigt werden – siehe **Abbildung 9**.
- Ziehen Sie die zwei unteren Schrauben fest.
- Die Schraubenköpfe mit den flachen Kappen (**Artikel 6**) verdecken.

### **Rechte Seite (in Fahrtrichtung)**

- Entfernen Sie die Mutter, die in **Abbildung 10** gekennzeichnet ist und entfernen Sie die Schraube vom Rahmen.
- Den Adventure-Sturzbügel für die rechte Seite (**Artikel 8**) in Position bringen wie in den **Abbildungen 11 und 12** abgebildet (siehe auch Abbildung für die rechte Seite oben).
- Die untere Halterung mit der längeren M8 Schraube und einer Unterlegscheibe (**Artikel 2 und 9**) sowie mit einer Unterlegschiebe und M8 Flanscmutter (**Artikel 2 und 10**) befestigen wie in **Abbildung 11** abgebildet - zu diesem Zeitpunkt nicht festziehen.
- Die zwei Distanzhalter an den M6 Schrauben (**Artikel 4 and 5**) montieren. Die Schrauben durch den oberen Adventure Bar-Sturzbügel in die obere Montagehalterung des unteren Adventure Bar-Sturzbügel einführen wie in **Abbildung 12** abgebildet. Die obere Schraube kann komplett eingeschraubt sein, aber die Hutmutter (**Artikel 7**) muss an den unteren Schrauben eingerastet sein, bevor sie festgezogen wird. Die übrige Mutter kann dann an der oberen Schraube befestigt werden – siehe **Abbildung 12**.
- Ziehen Sie die untere Mutter und Schraube fest.
- Die Schraubenköpfe mit den flachen Kappen (**Artikel 6**) verdecken.

AUSGABE 1 06/04/2021 (NSY)

R&G

Unit 1, Shelley's Lane, East Worldham, Alton, Hampshire, GU34 3AQ

Tel: +44 (0)1420 89007 Fax: +44 (0)1420 87301 [www.rg-racing.com](http://www.rg-racing.com) Email: [info@rg-racing.com](mailto:info@rg-racing.com)